

# DETERIORATION, DEFECTS AND REPAIR OF ABOVE THE GROUND SWIMMING POOLS AND SUPPORTED DECKS

Dunja Vla, Predrag Popovic  
*Wiss, Janney, Elstner Associates, Inc., Northbrook, IL, USA*

**WJE** | ENGINEERS  
ARCHITECTS  
MATERIALS SCIENTISTS



INTERNATIONAL  
**CONCRETE REPAIR**  
INSTITUTE

2018 Fall Convention |

**RESILIENCY**  
Above and Beyond Concrete BestGolf®

| November 7-9 | Omaha, Nebraska

## WHAT IS UNIQUE ABOUT THE ABOVE GROUND POOL STRUCTURES?

- Constantly exposed to harsh environment
  - Chemically treated water
  - High humidity
- Space below them is occupied
  - Used for storage
  - Parking
  - Office space
- When they leak it affects the space below them

### TYPES OF POOL FINISHES

- Ceramic tiles
- PVC liners
- Plaster
- Stainless steel

### TYPES OF DECK FINISHES

- Ceramic tiles
- Concrete
- Membrane
- Precast concrete pavers



## TYPES OF STRUCTURAL FRAMING

- **Conventionally reinforced concrete slabs and walls**
- **Pre / post tensioned concrete slabs and walls**
- **Concrete composite metal slabs with conventionally reinforced concrete walls supported by steel structural framing**

## TYPES OF DECK DRAINAGE

- **Linear drains along the deck**
- **Linear drains incorporated into the pool gutter**
- **Drain heads located below deck precast concrete pavers on pedestals**



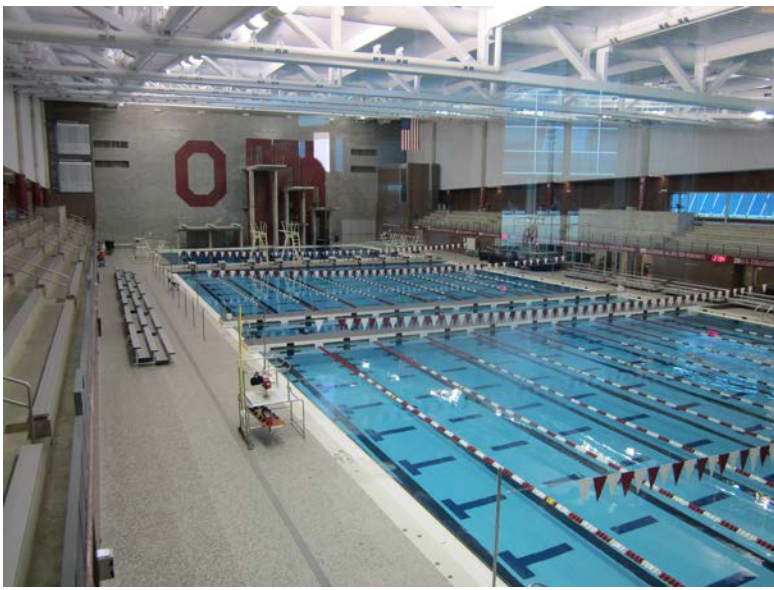

## INDOOR POOLS AT RECREATIONAL FACILITIES, SCHOOLS AND UNIVERSITIES

- Competition pools
- Leisure pools
- Kiddie pools



INTERNATIONAL  
**CONCRETE REPAIR**  
INSTITUTE

2018 Fall Convention |

**RESILIENCY**  
Above and Beyond Concrete BestGrip®

| November 7-9 | Omaha, Nebraska

# INDOOR POOLS AT HIGHRISES / CONDOMINIUM ASSOCIATIONS/ APARTMENT BUILDINGS



INTERNATIONAL  
**CONCRETE REPAIR**  
INSTITUTE

2018 Fall Convention |

**RESILIENCY**  
Above and Beyond Concrete BestGrip®

| November 7-9 | Omaha, Nebraska

# OUTDOOR POOLS AT APARTMENT COMPLEXES AND MUNICIPAL RECREATIONAL FACILITIES



INTERNATIONAL  
**CONCRETE REPAIR**  
INSTITUTE

2018 Fall Convention |

**RESILIENCY**  
Above and Beyond Concrete Restoration

| November 7-9 | Omaha, Nebraska

## TYPICAL DISTRESS

- Cracked and debonded tiles
- Cracked and deponded plaster
- Leakage
- Concrete delaminations /spalls
- Corrosion of metals
- Clogged drains / leaking drains
- Sealant - debonding / deteriorating / staining
- Damaged grates
- Bulkheads – deteriorated bearings
- Deteriorated retractable bleachers
- Corroded / broken wires supporting ducts at the ceiling of indoor pools



## CRACKED AND DEBONDED TILES

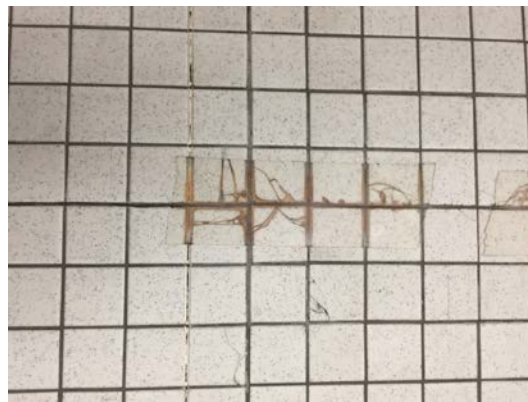

INTERNATIONAL  
**CONCRETE REPAIR**  
INSTITUTE

2018 Fall Convention |

**RESILIENCY**  
Above and Beyond Concrete Restoration

| November 7-9 | Omaha, Nebraska



# LEAKAGE



# CONCRETE DELAMINATION



# DIVING PLATFORMS

- Concrete deterioration at platform edges
- Corrosion of metal
- Peeling off rubber mats



# DRAINS



## REPAIR OF THE OLYMPIC SIZE POOL

- Pool and deck lined with ceramic tiles
- Three diving towers
- Two bulkheads
- Bleachers
- Underwater windows



INTERNATIONAL  
**CONCRETE REPAIR**  
INSTITUTE

2018 Fall Convention |

**RESILIENCY**  
Above and Beyond Concrete Restoration

| November 7-9 | Omaha, Nebraska



# POOL DECK CROSS SECTIONS

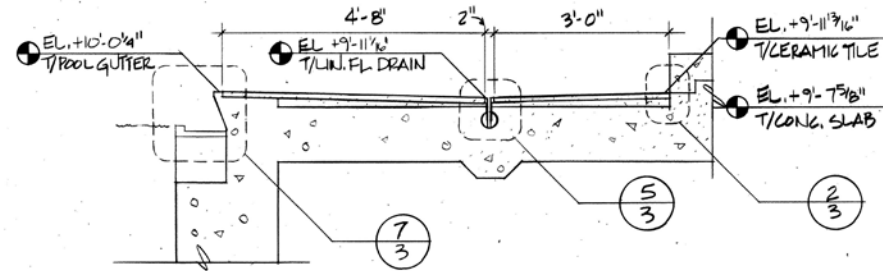
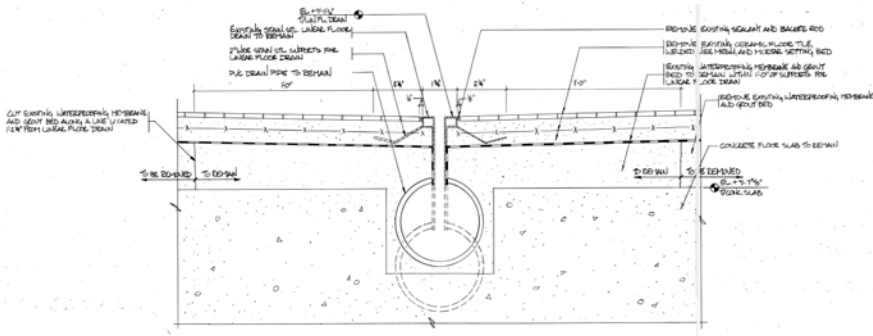
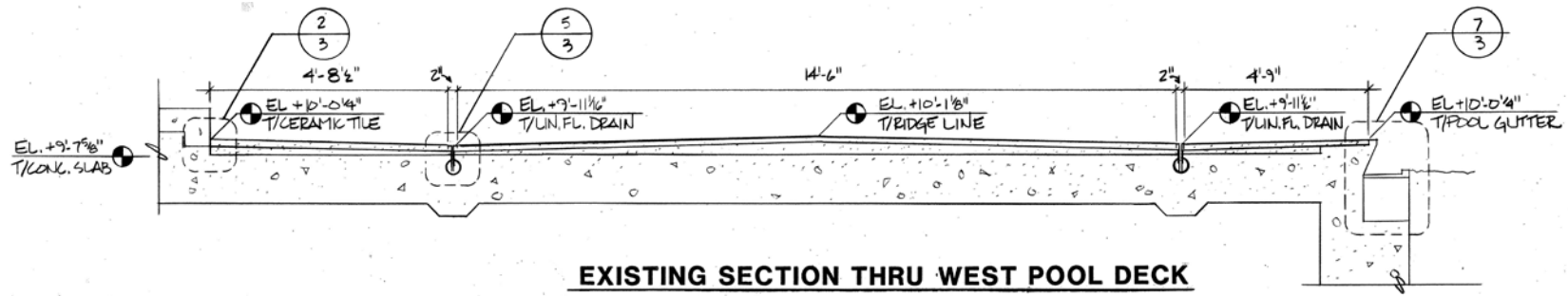

# LONGITUDINAL CROSS SECTION THROUGH THE POOL

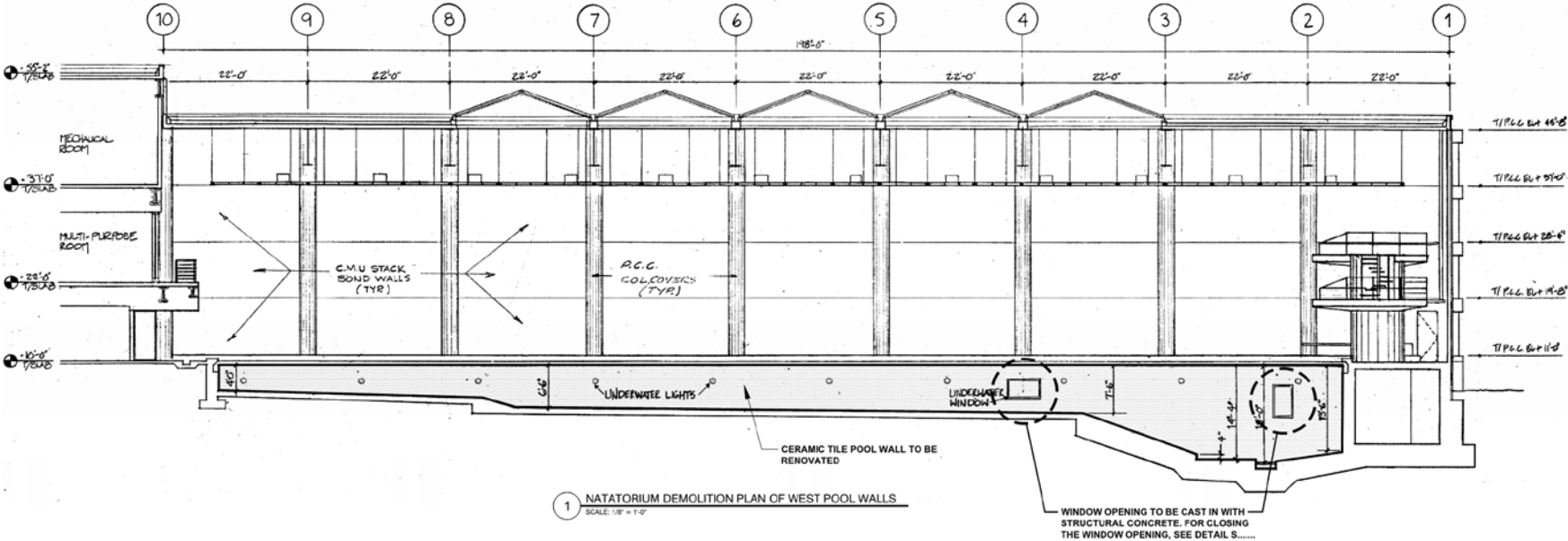







INTERNATIONAL  
**CONCRETE REPAIR**  
INSTITUTE

2018 Fall Convention |

**RESILIENCY**  
Above and Beyond Concrete BestGrip®

| November 7-9 | Omaha, Nebraska



INTERNATIONAL  
**CONCRETE REPAIR**  
INSTITUTE

2018 Fall Convention |

**RESILIENCY**  
Above and Beyond Concrete Restoration

| November 7-9 | Omaha, Nebraska



INTERNATIONAL  
**CONCRETE REPAIR**  
INSTITUTE

2018 Fall Convention |

**RESILIENCY**  
Above and Beyond Concrete. Restored.

| November 7-9 | Omaha, Nebraska

- UNDERSIDE OF THE DECK SLAB DELAMINATION AND WALLS SURVEY

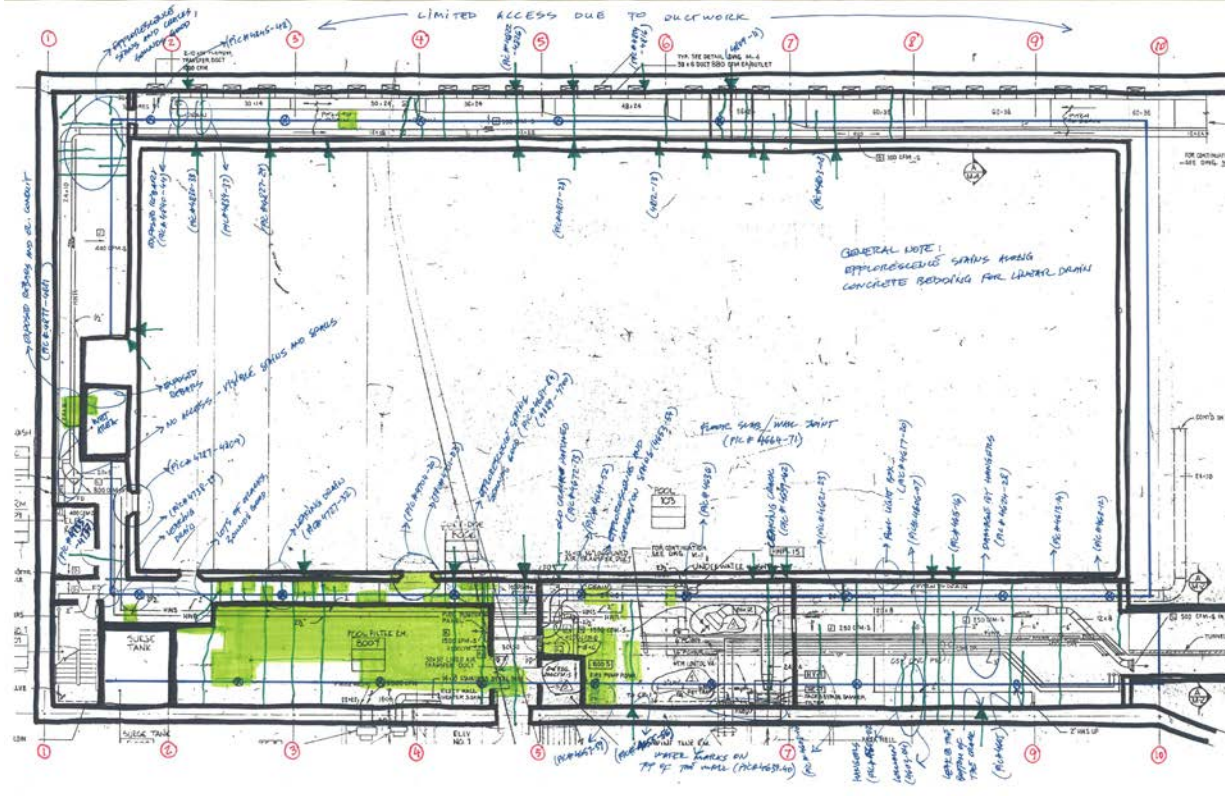



INTERNATIONAL  
**CONCRETE REPAIR**  
INSTITUTE

2018 Fall Convention |

**RESILIENCY**  
Above and Beyond Concrete Bestpractices™

| November 7-9 | Omaha, Nebraska

- **DELAMINATION AT UNDERWATER WINDOWS**



# • DELAMINATION SURVEY OF THE POOL WALLS AND BOTTOM

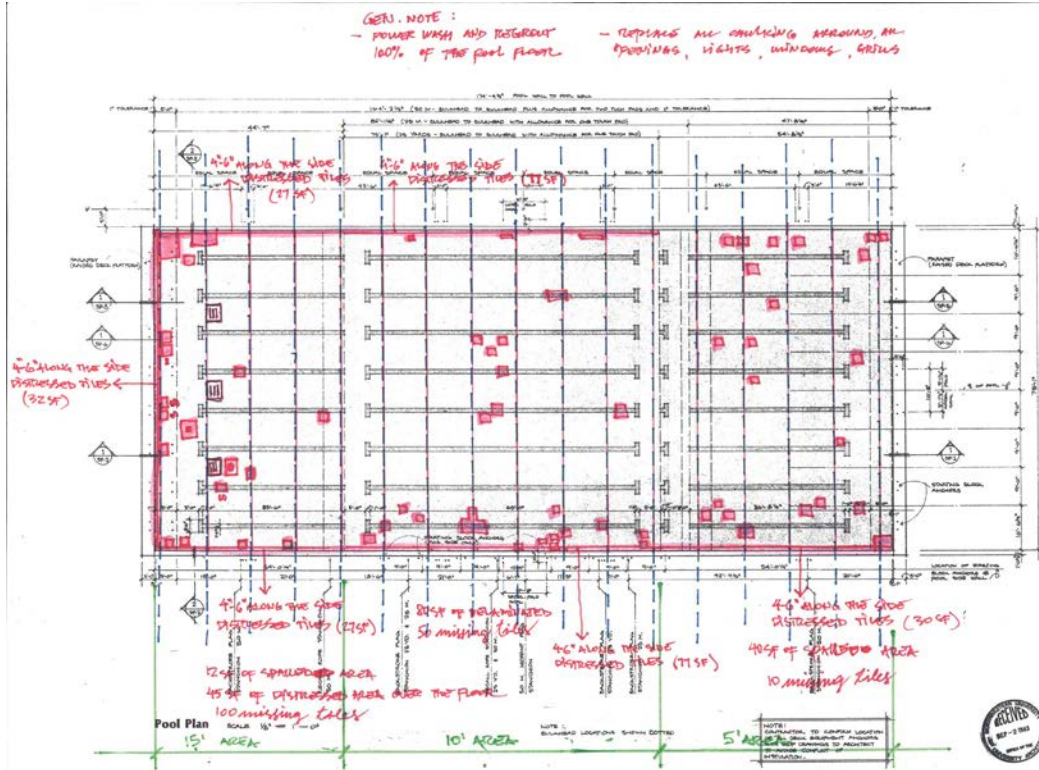



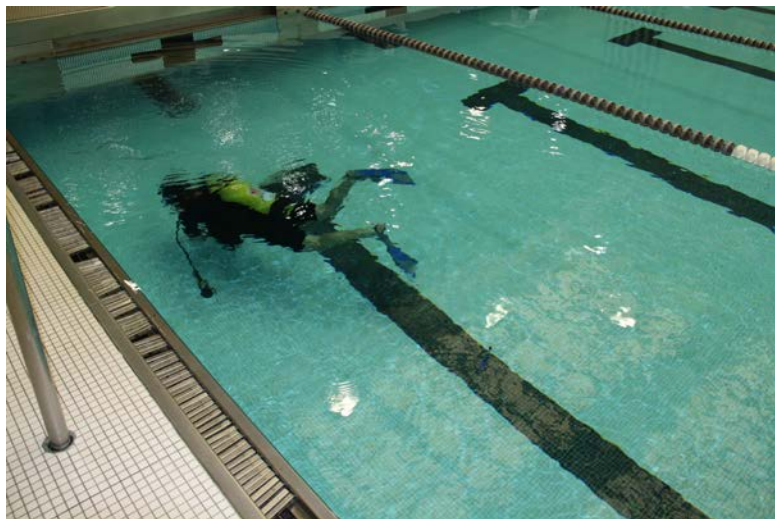

INTERNATIONAL  
**CONCRETE REPAIR**  
INSTITUTE

2018 Fall Convention |

**RESILIENCY**  
Above and Beyond Concrete Restoration

| November 7-9 | Omaha, Nebraska

- **BULKHEADS – WORN OUT BEARINGS AND CORROSION**

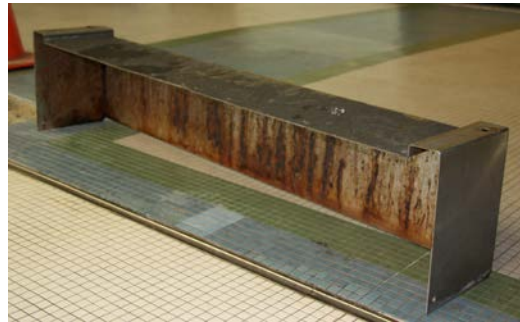
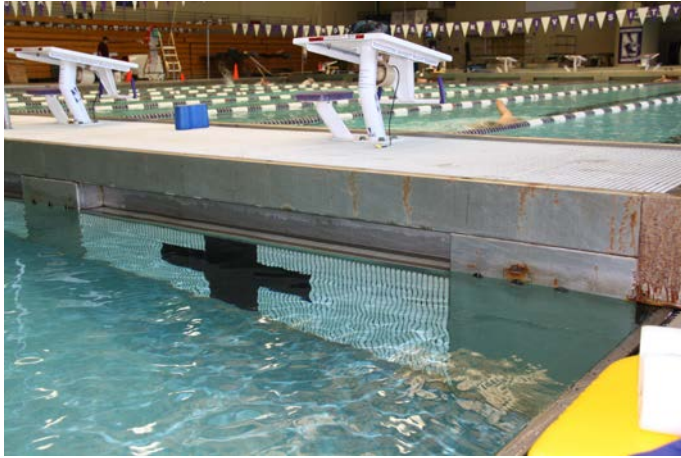

# REPAIRS



INTERNATIONAL  
**CONCRETE REPAIR**  
INSTITUTE

2018 Fall Convention |

**RESILIENCY**  
Above and Beyond Concrete. *Resiliently.*

| November 7-9 | Omaha, Nebraska

- **REPAIRS OF THE TOP OF THE DECK**





INTERNATIONAL  
**CONCRETE REPAIR**  
INSTITUTE

2018 Fall Convention |

**RESILIENCY**  
Above and Beyond Concrete Restoration

| November 7-9 | Omaha, Nebraska

- **REPAIRS OF THE UNDERSIDE OF THE DECK**



- **CASTING OF CONCRETE TOPPING OVER WATERPROOFED SLAB**



- **INSTALLTION OF TILES**







INTERNATIONAL  
**CONCRETE REPAIR**  
INSTITUTE

2018 Fall Convention |

**RESILIENCY**  
Above and Beyond Concrete BestGrip®

| November 7-9 | Omaha, Nebraska

- **REPAIRS INSIDE THE POOL**



- **CLEANING OF BULKHEADS**



## REPAIR OF THE POOL AT SENIOR INDEPENDENT LIVING HIGHRISE

- Pool lined with plaster
- Deck lined with ceramic tiles



# PLAN VIEW

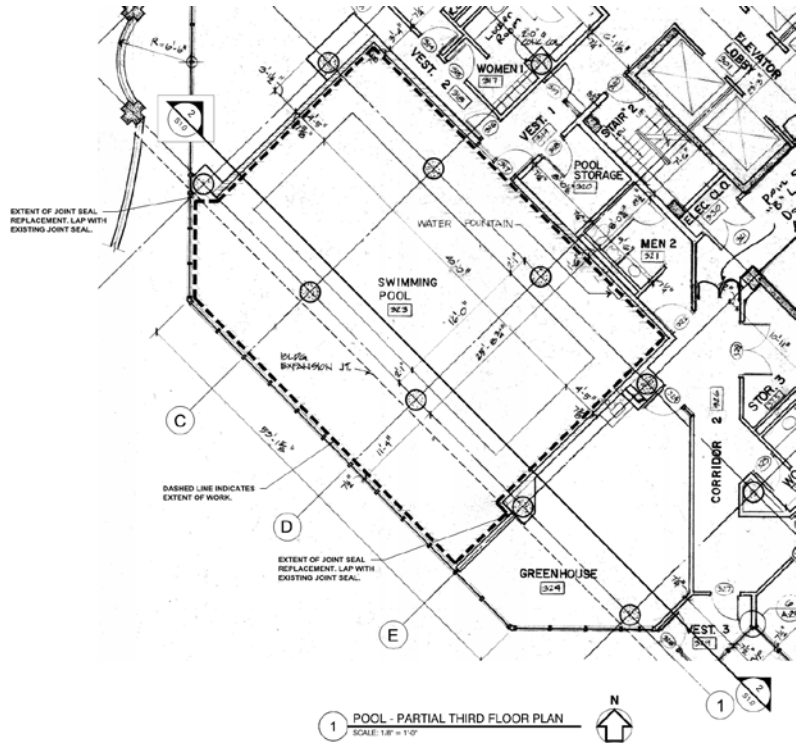

# CROSS SECTION THROUGH THE POOL

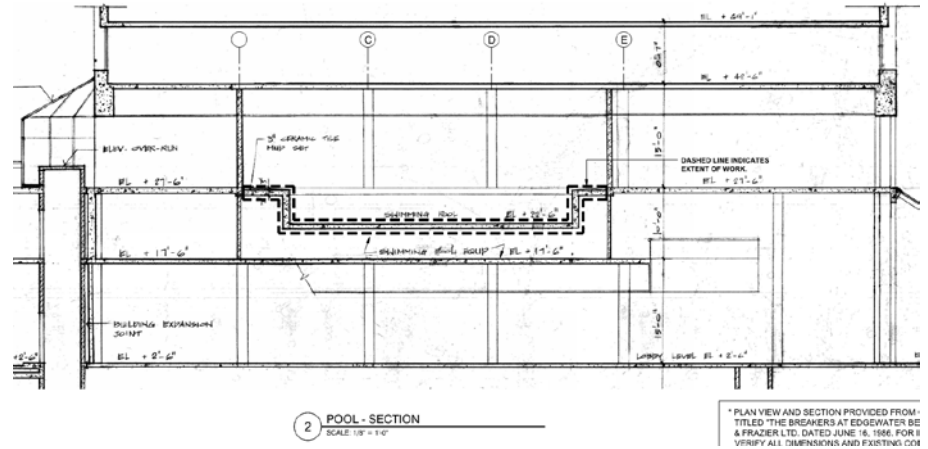

# CROSS SECTIONS THROUGH THE POOL WALLS AND SLAB

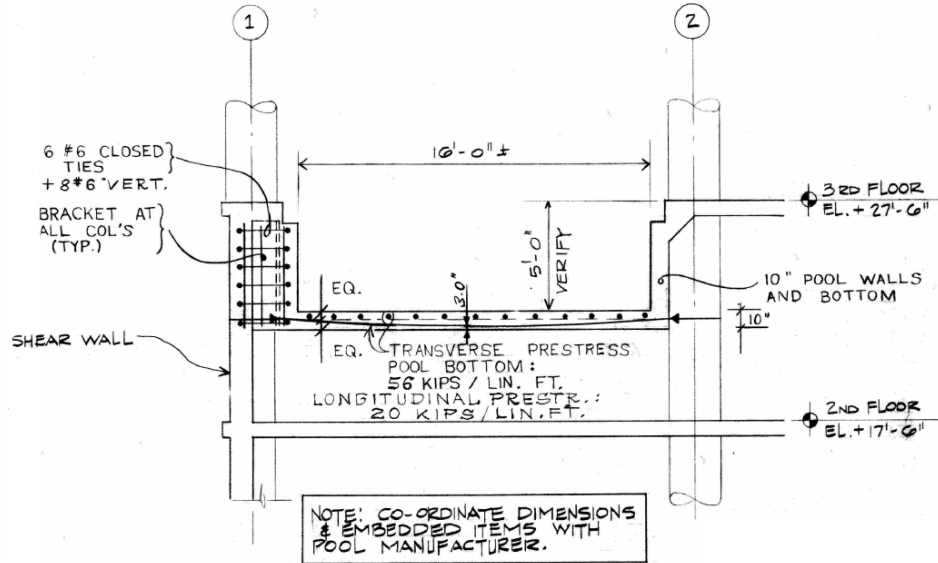

2 SECTION THRU SWIMMING POOL \*  
SCALE: 1/4" = 1'-0" (LOOKING NORTHWEST)

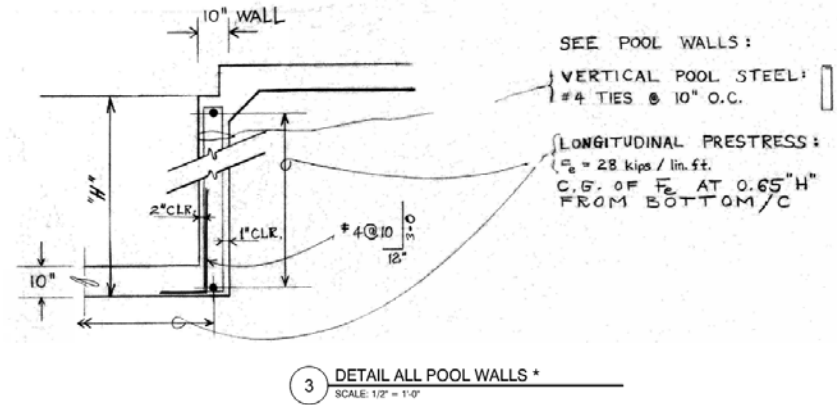

# INVESTIGATION



- **INSIDE THE POOL**
- **POOL DECK**



- **UNDERSIDE OF THE POOL**

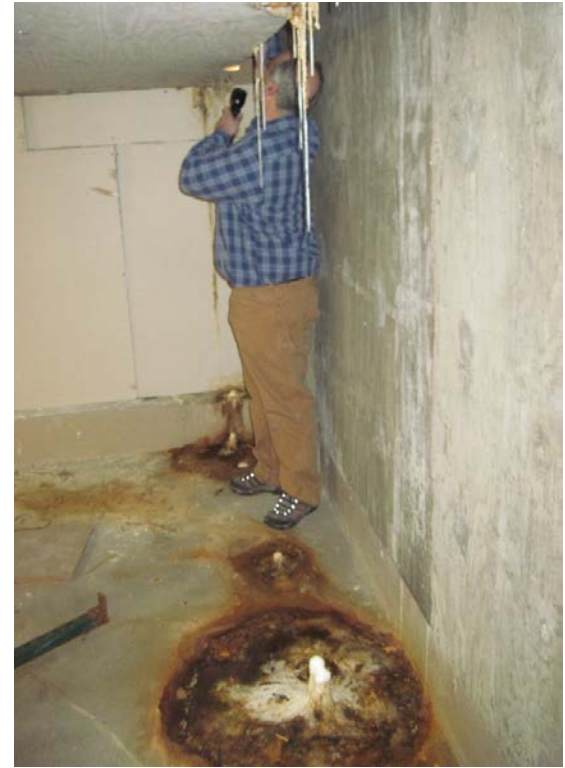





# REPAIRS



INTERNATIONAL  
**CONCRETE REPAIR**  
INSTITUTE

2018 Fall Convention |

**RESILIENCY**  
Above and Beyond Concrete Bestpractices™

| November 7-9 | Omaha, Nebraska

- TOP OF THE DECK AND INSIDE THE POOL



- UNDERSIDE OF THE POOL





INTERNATIONAL  
**CONCRETE REPAIR**  
INSTITUTE

2018 Fall Convention |

**RESILIENCY**  
Above and Beyond Concrete BestGrip®

| November 7-9 | Omaha, Nebraska

- **RETROFIT OF A GUTTER**

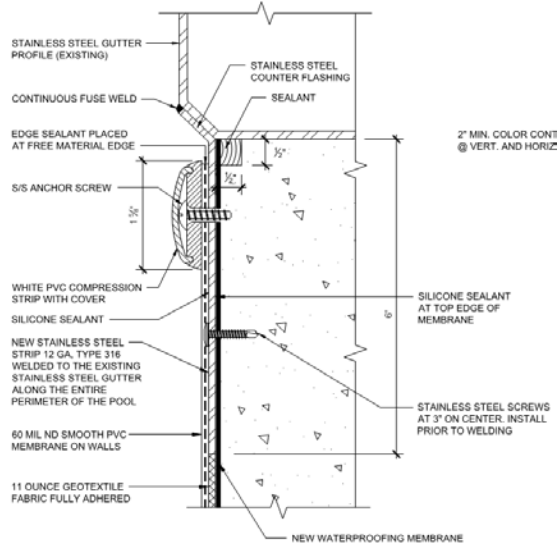

Repair detail – installation of gutter skirt



- **INSTALLATION OF SETTING BED, WATERPROOFING MEMEBRANE AND DECK TILES**



- **INSTALLATION OF WATERPROOFING MEMEBRANE INSIDE THE POOL**





- **INSTALLATION OF PVC LINER**





INTERNATIONAL  
**CONCRETE REPAIR**  
INSTITUTE

2018 Fall Convention |

**RESILIENCY**  
Above and Beyond Concrete Bestpractices™

| November 7-9 | Omaha, Nebraska

# RESTORED POOL



INTERNATIONAL  
**CONCRETE REPAIR**  
INSTITUTE

2018 Fall Convention |

**RESILIENCY**  
Above and Beyond Concrete Restorations

| November 7-9 | Omaha, Nebraska

# REPAIRS OF DIVING TOWER

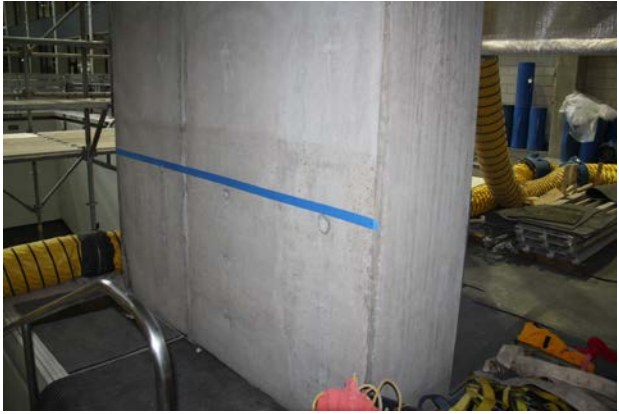

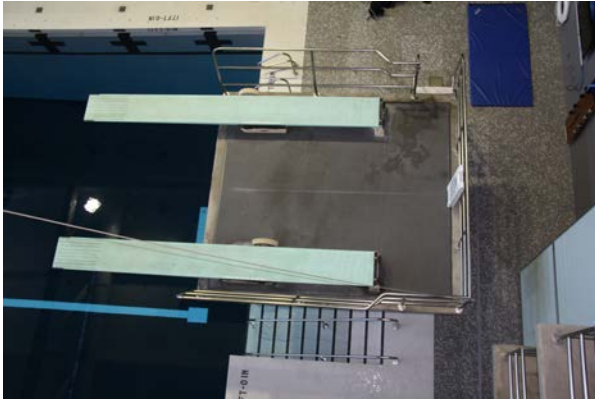

INTERNATIONAL  
**CONCRETE REPAIR**  
 INSTITUTE

2018 Fall Convention |

**RESILIENCY**  
 Above and Beyond Concrete Restoration

| November 7-9 | Omaha, Nebraska